

THE INFORMATION CONTAINED IN THIS DRAWING IS THE SOLE PROPERTY OF NEAT-PATCH ANY REPRODUCTION IN PART OR WHOLE WITHOUT THE WRITTEN PERMISSION OF NEAT-PATCH IS PROHIBITED.

REV	ECO#	DESCRIPTION	DATE	DRAWN

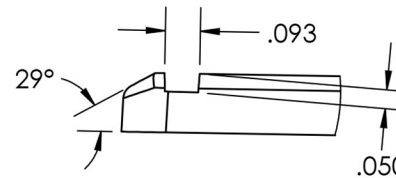

DETAIL A
SCALE 2 : 1

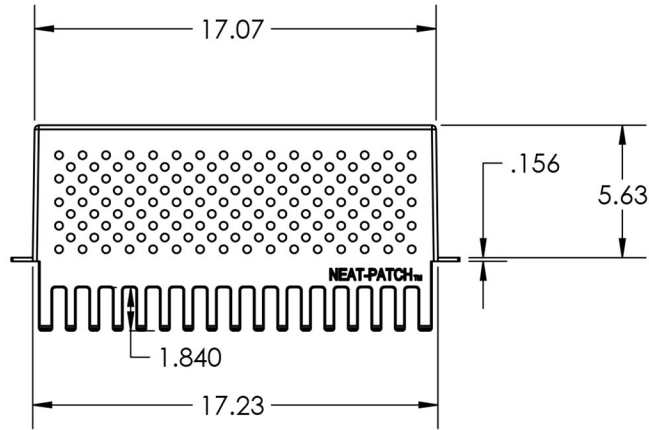
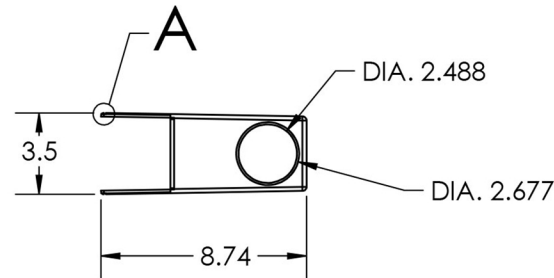
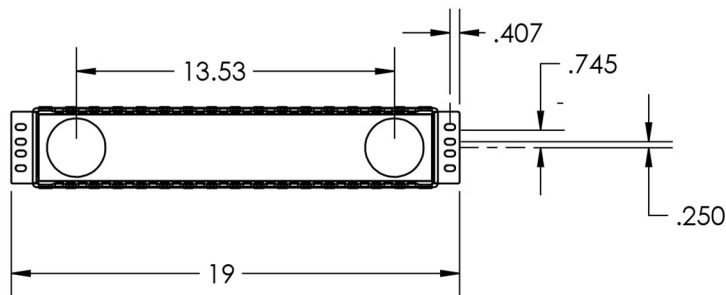
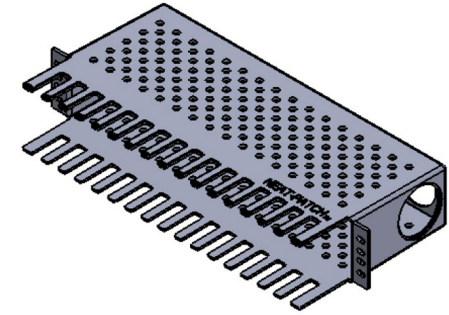

METRIC TOLERANCE (UNLESS OTHERWISE SPECIFIED)		INCH TOLERANCE (UNLESS OTHERWISE SPECIFIED)	
DECIMALS	ANGLES	DECIMALS	ANGLES
.X +/- .254	+/- 1 DEG.	.XX +/- .010	+/- 1 DEG.
.XX +/- .127		.XXX +/- .005	
.XXX +/- .05		.XXXX +/- .002	

MATERIAL	--
FINISH	--
DO NOT SCALE DRAWING	

	NAME	DATE
DRAWN	CEB	6-24-16
CHECKED		
ENG APPR.		
MFG APPR.		
Q.A.		

COMMENTS:

NEAT-PATCH™

TITLE:
CABLE STORAGE MANAGER
ENCLOSURE

PART NO:

SIZE: **A** DWG. NO. REV.

SCALE: 1:8 WEIGHT: SHEET 1 OF 1

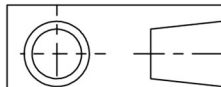

THE INFORMATION CONTAINED IN THIS DRAWING IS THE SOLE PROPERTY OF NEAT-PATCH ANY REPRODUCTION IN PART OR WHOLE WITHOUT THE WRITTEN PERMISSION OF NEAT-PATCH IS PROHIBITED.

REV	ECO#	DESCRIPTION	DATE	DRAWN

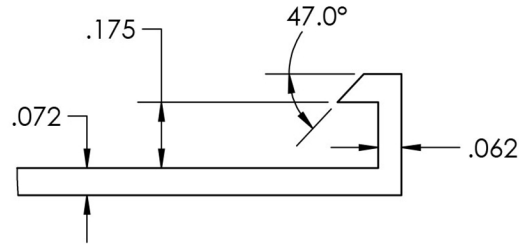
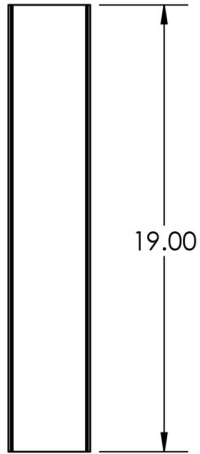

DETAIL A
SCALE 2 : 1

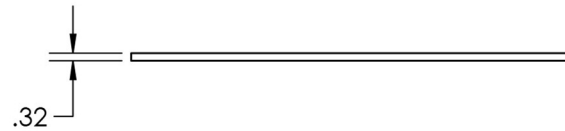
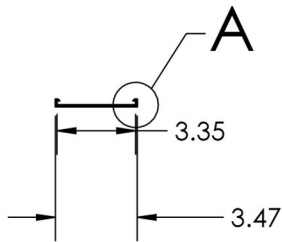
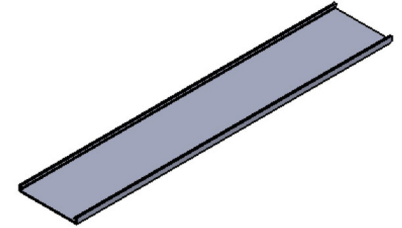

METRIC TOLERANCE (UNLESS OTHERWISE SPECIFIED)		INCH TOLERANCE (UNLESS OTHERWISE SPECIFIED)	
DECIMALS	ANGLES	DECIMALS	ANGLES
.X +/- .254	+/- 1 DEG.	.XX +/- .010	+/- 1 DEG.
.XX +/- .127		.XXX +/- .005	
.XXX +/- .05		.XXXX +/- .002	

MATERIAL	--
FINISH	--
DO NOT SCALE DRAWING	

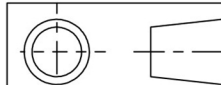

	NAME	DATE
DRAWN	CEB	6-24-16
CHECKED		
ENG APPR.		
MFG APPR.		
Q.A.		

COMMENTS:

NEAT-PATCH™

TITLE:
CABLE STORAGE MANAGER
ENCLOSURE LID

PART NO:		REV.
SIZE A	DWG. NO.	
SCALE:1:8	WEIGHT:	SHEET 1 OF 1